

Ylide-Initiated Michael Addition–Cyclization Reactions beyond Cyclopropanes

XIU-LI SUN AND YONG TANG*

State Key Laboratory of Organometallic Chemistry, Shanghai Institute of Organic Chemistry, The Chinese Academy of Sciences, 354 Fenglin Lu, Shanghai 200032, China

RECEIVED ON APRIL 14, 2008

CON SPECTUS

Ylides are nucleophiles that bear a unique leaving group, L_nM , and can attack aldehydes, ketones, imines, and electron-deficient alkenes. Over the course of the reaction, they react with $C=X$ ($X = C, N, O$, etc.) double bonds to form betaine or oxetane intermediates, which further eliminate the heteroatom-containing group in one of two ways to give the corresponding olefination or cyclization product. Since the discovery of the Wittig reaction, ylide olefination has developed as one of the most useful approaches in constructing carbon–carbon double bonds. These reactions provide unambiguous positioning of the $C-C$ double bond and good stereoselectivity. Researchers have also widely used ylides for the synthesis of small ring compounds such as epoxides, cyclopropanes, and aziridines. However, the use of ylides to prepare larger cyclic structures was very limited.

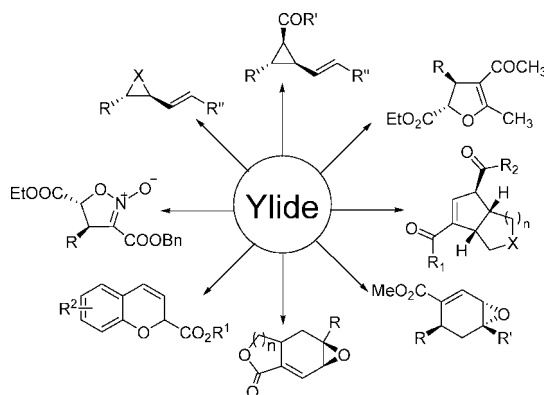

This Account outlines our recent work on ylide-initiated Michael addition/cyclization reactions. By altering the heteroatoms and the ligands of the ylides, we have modulated the reactivity of ylides. These modified ylides provide easy access to diverse cyclic compounds with the ability to control regioselectivity, chemoselectivity, diastereoselectivity, and enantioselectivity. Reactions using these ylides produce the structural components of many biologically active compounds and valuable intermediates in organic synthesis. Allylic telluronium and sulfonium ylides can react with α,β -unsaturated esters, ketones, amides, and nitriles to afford multisubstituted vinylcyclopropanes with high selectivities. Telluronium allylides react with aromatic *N*-phenyl aldimines to give *trans*-vinylaziridines and with chiral *N*-*tert*-butylsulfynylimines to afford the optically active *cis*-2-substituted vinylaziridines, both with high diastereoselectivities. We also used sulfonium and telluronium allylides to prepare vinyl epoxides.

In addition, ylides are good reagents for the synthesis of five-membered heterocyclic compounds. By treatment of stable camphor-derived sulfur ylides with α -ylidene- β -diketones, we obtained multisubstituted dihydrofurans with high diastereo- and enantioselectivities. Ammonium salts derived from cinchonidine and cinchonine react smoothly with 3-aryl and 3-heteroaryl-2-nitro acrylates, affording both enantiomers of isoxazoline *N*-oxides with up to 99% ee.

Ylides can initiate tandem cyclizations for the synthesis of chromenes, bicyclic compounds, and cyclohexadiene epoxides. Varying the choice of base allows access to 2*H*-chromenes and 4*H*-chromenes from 3-(2-(bromomethyl)phenoxy)acrylates via a tandem ylide Michael addition/elimination/substitution reaction. Phosphines can catalyze an intramolecular ylide [3 + 2] annulation constructing bicyclo[*n*.3.0] ring systems with three contiguous stereogenic centers. The reaction of crotonate-derived sulfur ylides with α,β -unsaturated ketones affords cyclohexadiene epoxides with excellent diastereoselectivities (>99/1) in good to high yields. Using a camphor-derived sulfonium salt, we have produced asymmetric cyclohexadiene epoxides with high ee's. Overall, these results illustrate the versatility and tunability of ylides for the preparation of cyclic systems containing more than three atoms.

Introduction

The birth of the Wittig reaction marked the entry of ylides into the arsenal of important synthetic tools. An ylide, $L_nM^+-C^--RR'$, can be regarded as a nucleophile bearing a unique leaving group, L_nM . Different from common nucleophiles, it can initiate a nucleophilic addition to aldehyde, ketone, imine, and electron-deficient alkene and then displace the leaving group via an intramolecular substitution to form a cyclic compound (route 1 in Scheme 1). One of the advantages is that both the reactivity of an ylide and the selectivity of an ylide reaction can be modulated readily by the heteroatom M and the ligand L . Moreover, the heteroatom compound L_nM could be easily recovered and reused under certain circumstance, leading to the developments of catalytic ylide cyclization^{1,2} in the past decade. These advantages, together with its ready accessibility, make ylide cyclization a useful method for the synthesis of small ring compounds,^{1–3} such as epoxides, cyclopropanes, and aziridines.

As our initial investigations in ylidic cyclization, we decided to focus on reactions of ylides with Michael acceptors for the synthesis of cyclopropanes because cyclopropane derivatives are ubiquitous structural components of many biologically active compounds and valuable intermediates in organic synthesis. With regard to the choice of ylides, we selected allylides since the products are useful multisubstituted vinylcyclopropanes and general methods for the synthesis of such compounds are lacking due to the difficulties associated with regioselectivity, diastereoselectivity, and enantioselectivity. On the basis of the cyclopropanation mechanism, we reasoned that intermediate **I** of the Michael addition of ylide might further be trapped by a second electrophile and then trigger a tandem cyclization reaction to furnish diverse cyclic compounds (route 2 in Scheme 1). Thus, we explored the ylide-initiated Michael addition/tandem cyclization to form cyclic compounds beyond three-membered rings, and various cyclic compounds outlined in Scheme 2 are prepared with high selectivities via an ylide route.

Ylide-Initiated Michael Addition/Substitution Cyclization. From Three- to Five-Membered Rings

Carbon–carbon bond formation is one of the most essential and effective tools for the construction of organic molecules. Ylide-initiated Michael addition/substitution proved to be very efficient for several carbon–carbon bond-forming reactions involved in the synthesis of cyclic compounds.

SCHEME 1. Possible Pathways for Ylide-Initiated Tandem Cyclization

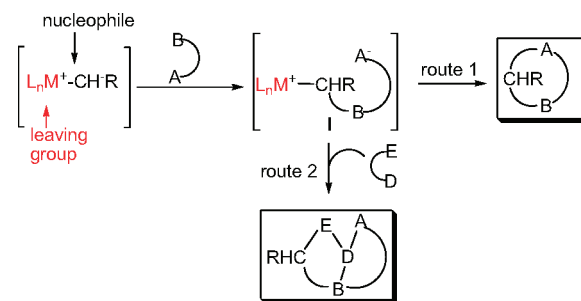

SCHEME 2. Various Cyclic Products via Ylidic Cyclization

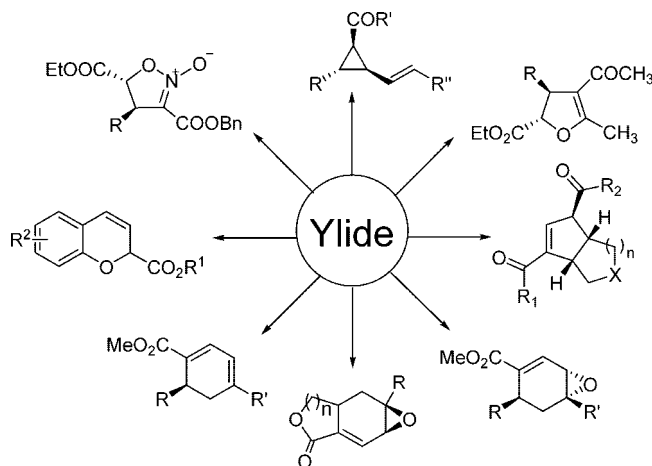

SCHEME 3. Control Synthesis of Both Cyclopropane Diastereomers^{7,8}

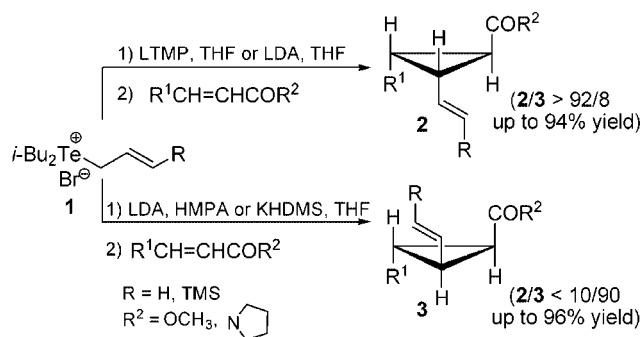

Michael Addition/Substitution To Form Vinylcyclopropanes. Considering that allylic sulfur ylide is easily rearranged⁴ and allylic telluronium ylide is more reactive than the corresponding sulfur ylide,⁵ telluronium allylides were chosen for our initial study. We found that telluronium allylides could react with α,β -unsaturated esters and amides to provide the vinylcyclopropane derivatives in high yields with high stereoselectivities.⁶ Interestingly, the diastereoselectivities of this cyclopropanation were easily controlled by varying the reaction conditions (Scheme 3).^{7–9}

SCHEME 4. Synthesis of Telluronium Salts **7a–c** and **8a–c**

TABLE 1. Stereoselective Synthesis of Vinylcyclopropanes via Chiral Telluronium Ylide

R ¹	R ²	dr	yield (%)	ee (%)
Ph	OMe	96/4	95	96
<i>p</i> -MeOC ₆ H ₄	OMe	97/3	63	94
<i>p</i> -MeC ₆ H ₄	OMe	98/2	88	97
<i>p</i> -CF ₃ C ₆ H ₄	OMe	88/12	99	96
<i>p</i> -BrC ₆ H ₄	OMe	97/3	97	96
2-furyl	OMe	94/6	81	97
Me	OMe	92/8	57	94
Ph	Ph	98/2	95	95
Ph	N(CH ₂) ₅	99/1	83	93

Although exciting methods have been reported for the construction of cyclopropanes,^{1c,3,10,11} direct synthesis of optically active disubstituted vinylcyclopropane derivatives remains underdeveloped. The excellent diastereoselectivity in aforementioned reactions encouraged us to develop chiral telluronium ylides for the synthesis of optically active cyclopropanes. Thus, we designed new chiral telluronium salts **7** and **8**, which were readily prepared from hexane-2,5-dione **4** as shown in Scheme 4.¹²

Silylated telluronium tetraphenyl borate **8b**, after in situ deprotonation by LiTMP/HMPA, reacted smoothly with a variety of β -aryl- and β -heteroaryl- α,β -unsaturated carbonyl compounds to furnish 1,2-*cis*-vinylcyclopropanes **3** with high diastereoselectivities (dr > 88/12) and enantioselectivities (93–99% ee) in high yields (up to 99%) (Table 1). α,β -Unsaturated ketones gave 1,2-*cis*-vinylcyclopropanes with high chemoselectivity, and no epoxides were detected. Telluronium salts **8a** and **8c** gave products with similar selectivities but in lower yields.

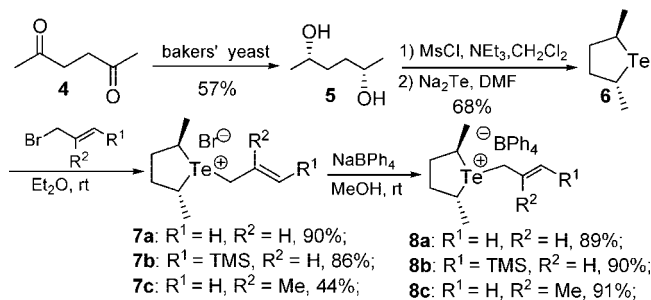
Interestingly, by using LDA/LiBr instead of LiTMP/HMPA as a base, the reaction of telluronium salt **8b** with β -aryl- α,β -unsaturated esters and amides afforded 1,2-*trans*-vinylcyclopropanes **2** instead of **3** with good to high diastereoselectivities and enantioselectivities. For cinnamates,¹³ unexpectedly, additives LiBr and MgBr₂ gave the same dias-

SCHEME 5. Base-Reversed Enantioselectivities

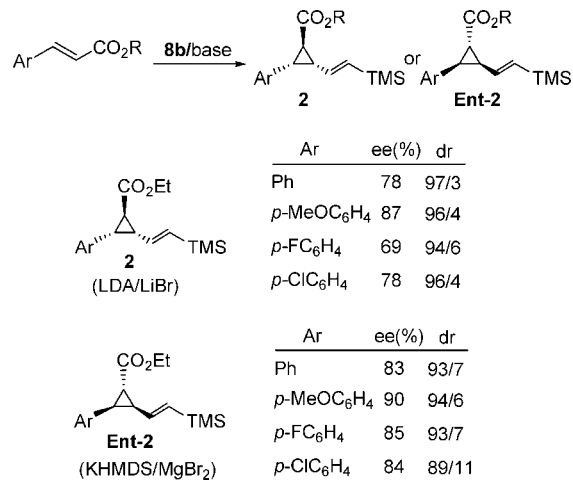

SCHEME 6. Chiral Telluronium and Sulfonium Salts

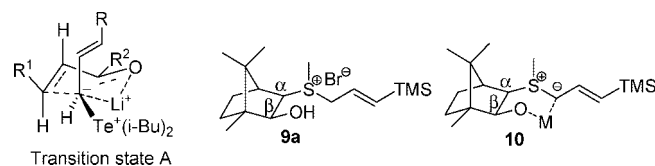

tereoselectivities but opposite enantioselectivities (Scheme 5). Thus, three isomers, **2**, **3**, and ent-**2** of eight optically active vinylcyclopropanes were synthesized with good selectivities by the choice of reaction conditions when cinnamates are employed.¹³

The above results indicate that the stereoselectivities of the telluronium allylide cyclopropanation can be switched readily by a proper choice of the reaction conditions, of which lithium or magnesium ion plays a key role in tuning the diastereoselectivity. In the presence of lithium ion, we proposed a chelating six-membered ring transition state **A** (Scheme 6) to explain the formation of the major product **2**. Based on this assumption, camphor-derived sulfonium salt **9a**¹⁴ with a hydroxy group at the β -position of the sulfur atom was designed. It is envisaged that the corresponding ylide **10** might form a rigid six-membered ring in the presence of metal ion such as lithium ion and thus be beneficial to the diastereoselectivity and enantioselectivity of the cyclopropanation.

Sulfonium salt **9a** can be prepared from cheap *d*-camphor in three steps in a 10-g scale (Scheme 7).^{15,16} Treatment of **9a** with lithium diisopropylamide (LDA), followed by the addition of methyl cinnamate gave only a trace amount of the desired product **2b** due to the [2,3]-sigmatropic rearrangement of the ylide (Scheme 8). To prevent the ylide rearrangement, a one-pot procedure using a weaker base than LDA was examined. Vinylcyclopropane **2b** was obtained with 97% ee

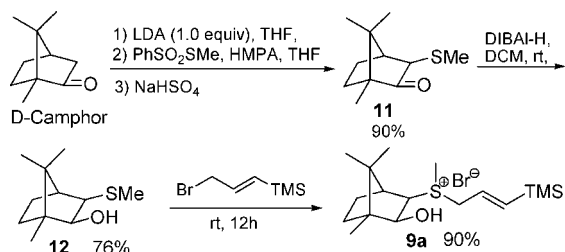
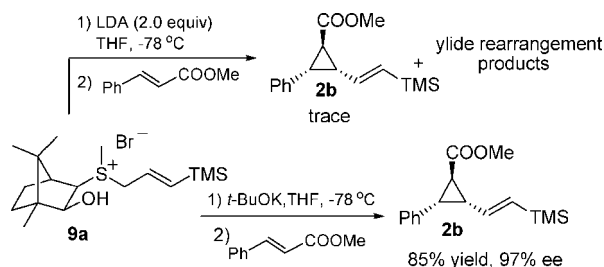
SCHEME 7. Synthesis of Sulfonium Salt **9a**

SCHEME 8. Effects of Reaction Conditions on Sulfur Ylide Cyclopropanation

TABLE 2. Cyclopropanation Using *d*-Camphor-Derived Sulfonium Salt **9a**

R	EWG	dr	yield (%)	ee (%)
Ph	CO ₂ Me	>99/1	85	97
2-furyl	CO ₂ Et	>99/1	57	97
Ph	CON(CH ₂) ₅	>99/1	70	97
Ph	COBu ^t	92/8	64	95
Ph	CN	>99/1	61	94
H	CO ₂ Me	>99/1	83	95
Me	CO ₂ Me	86/14	20	92

in 85% yield when salt **9a**, *t*-BuOK, and methyl cinnamate were mixed at $-78\text{ }^{\circ}\text{C}$ in THF (Scheme 8).¹⁶

β -Aryl- α,β -unsaturated esters, ketones, amides, and nitriles worked smoothly under the same conditions to afford the corresponding 1,2-*trans*-vinylcyclopropane with excellent enantioselectivities and diastereoselectivities (Table 2).

Interestingly, the enantioselection of cyclopropanation is reversed when the corresponding *endo*-sulfonium ylide is employed. Some representative examples are listed in Table 3. Most α,β -unsaturated esters, ketones, amides, and nitriles examined proved to be suitable substrates. Thus, both enantiomers of 1,2-disubstituted, 1,2,3-trisubstituted, and 1,1,2-trisubstituted cyclopropanes were easily prepared with high to excellent enantioselectivities in reasonable yields from the same chiral source, *d*-camphor.

The camphor-derived β -hydroxyl-sulfonium salts **9** and **13** proved to be efficient reagents for the cyclopropanation of electron-deficient alkenes. Experimental results in Scheme 9

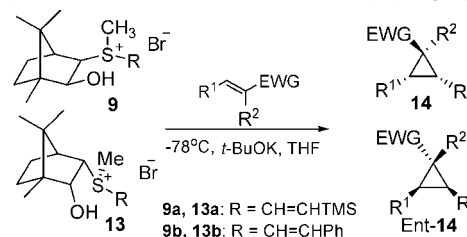
TABLE 3. Synthesis of Both Enantiomers of Vinylcyclopropane

R ¹ /R ²	EWG	14 (9a)		ent- 14 (13a)	
		yield (%)	ee (%)	yield (%)	ee (%)
Ph/H	CON(C ₂ H ₄) ₄	70	97	72	96
H/H	CO ₂ Me	83	95	55	93
Ph/H	CO ₂ Me	77	99	86	98
C ₄ H ₉ /H	CO ₂ Me	78	87	72	90
H/H	CO ₂ Me	90	93	60	91
<i>p</i> -ClC ₆ H ₄ /H	COBu ^t	91	98	91	98
C ₄ H ₉ /H	COBu ^t	88	70	81	90
Ph/H	CON(C ₂ H ₄) ₄	98	98	87	96
H/H	CON(C ₂ H ₄) ₄	70	90	78	98
<i>p</i> -BrC ₆ H ₄ /H	CN	83	96	75	95
H/CH ₂ Ph	CO ₂ Me	83	88	78	97

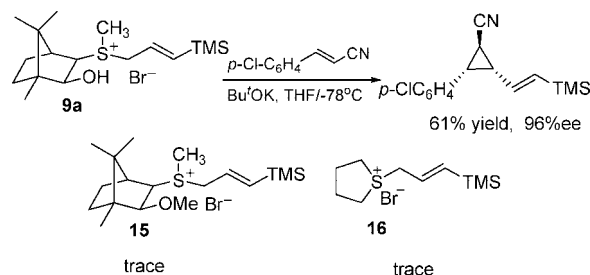
SCHEME 9. Effect of the Free Hydroxyl Group on the Cyclopropanation

suggested that the free hydroxyl groups in **9a** must play a crucial role in controlling both the reactivity and stereoselectivity.

DFT calculations showed that the cyclopropanation proceeded preferably via a ten-membered transition state, in which the H–O–C–C–S–C moiety is in a boat-like conformation and the hydrogen bond is very strong (Figure 1).¹⁶ These models gave excellent explanations for the high selectivities and the opposite enantioselectivities of *exo*- and *endo*-sulfur ylide cyclopropanation reactions.

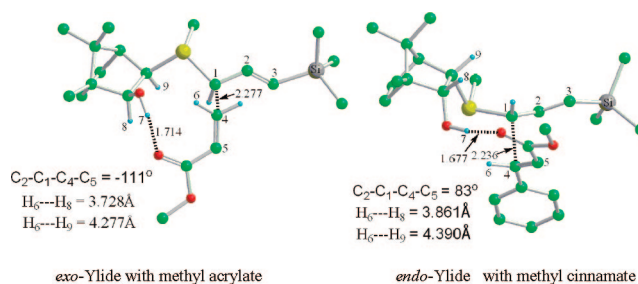
FIGURE 1. DFT-calculated transition state for *exo*- and *endo*-sulfur ylide cyclopropanation.

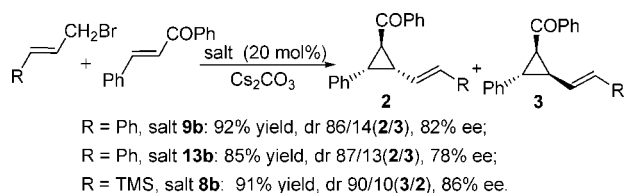
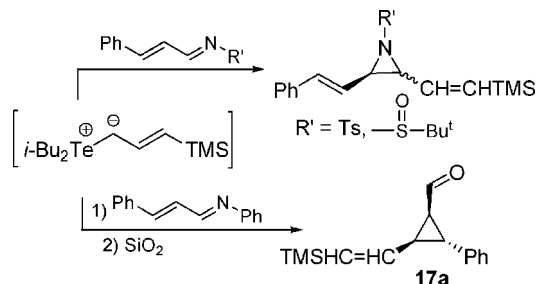
SCHEME 10. Asymmetric Catalytic Ylide Cyclopropanation of Chalcones**SCHEME 11.** Effects of *N*-Substituents on Chemoselectivity

In the cyclopropanation reactions of sulfonium and tellurium ylides, the chiral sulfide and telluride can be recovered, respectively. These results prompted us to develop their catalytic version.^{12,16} To our delight, *exo*-sulfonium salt **9b** and *endo*-sulfonium salt **13b**, as well as tellurium salt **8b**, can catalyze the cyclopropanation reaction of chalcone with silylated allylic bromide or cinnamyl bromide, furnishing 1,2,3-trisubstituted-vinylcyclopropane derivatives as major products in good to high yields with good enantioselectivities (Scheme 10).^{12,16} The optimal catalyst loading is 20 mol %.

It was reported that the reaction of tellurium allylide with α,β -unsaturated aldehyde gave the epoxides chemoselectively.^{5,17} Our studies described above showed that the reaction of tellurium allylide with α,β -unsaturated ketones furnished cyclopropanes without the detection of any epoxide.¹² We were very curious about the chemoselectivity of the reaction of tellurium allylide with α,β -unsaturated imines. Interestingly, we found that the chemoselectivity of the reaction was *N*-substituent-dependent (Scheme 11). When *N*-sulfonyl or *N*-sulfinyl imines were selected as substrates, only aziridines were obtained.¹⁸ However, tellurium silylated allylide reacted with *N*-phenyl imine in a 1,4-addition manner to afford cyclopropanecarbaldehyde **17a** with diastereoselectivity of dr > 99/1 in 85% yield.¹⁸ Therefore, the chemoselectivity of the ylide reaction with α,β -unsaturated imine was controlled by a proper selection of the *N*-substituents. The probably reason is that the *N*-substituents change the charge distribution of α,β -unsaturated imines. The clear reason waits for further investigation.

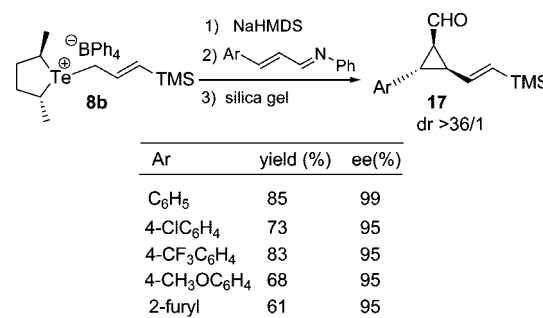
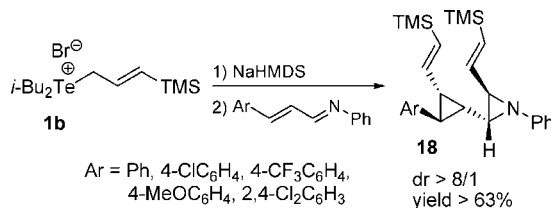
SCHEME 12. Asymmetric Cyclopropanation of α,β -Unsaturated Imines with Tellurium Ylides**SCHEME 13.** Synthesis of Cyclopropylaziridines

Using chiral tellurium salt **8b**, β -aryl and β -heteroaryl- α,β -unsaturated imines furnished 1,2-*cis*-cyclopropanecarbaldehyde with excellent diastereoselectivities (dr > 36/1) and enantioselectivities (>95% ee) in good yields (Scheme 12). Substituents on the aryl ring proved to be well-tolerated.

We proposed that the cyclopropanecarbaldehyde was formed via an ylide 1,4-addition to α,β -unsaturated imines, followed by hydrolysis on silica gel. Increasing the molar ratio of tellurium salt **1b** to imines from 1:1 to 3:1 resulted in the production of vinylcyclopropylaziridines **18** in good yields (63–86%) with high diastereoselectivities (Scheme 13), providing an easy access to cyclopropylaziridines.¹⁸

Both tellurium and sulfonium allylides can react with α,β -unsaturated carbonyl compounds to give 1,2-disubstituted or 1,2,3-trisubstituted cyclopropanes. Tellurium salt **1b** also reacted with arylidene malonates to afford 1,1,2,3-tetrasubstituted cyclopropanes diastereoselectively,¹⁹ which are very useful synthetic intermediates in the construction of cyclopentane skeleton and heterocyclic compounds.²⁰ However, the substrates for this reaction are limited to arylidene malonates. When the corresponding arsonium salts **19** were used instead, both alkylidene and arylidene malonates proceeded well to give *trans*-2,3-disubstituted cyclopropane 1,1-dicarboxylic esters with high selectivities (Scheme 14).²¹ A recent study showed that the triphenylarsine loading could be reduced from a stoichiometric amount to a catalytic amount (20 mol %) using 2-phenylvinyltosylhydrazone salt in the presence of a catalytic amount of Rh₂(OAc)₄.²²

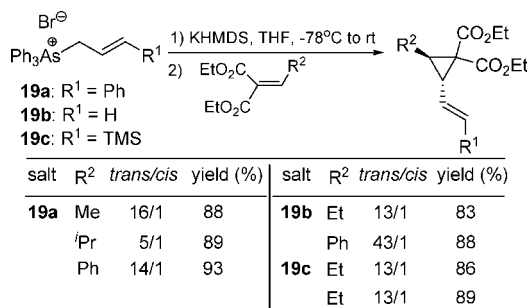
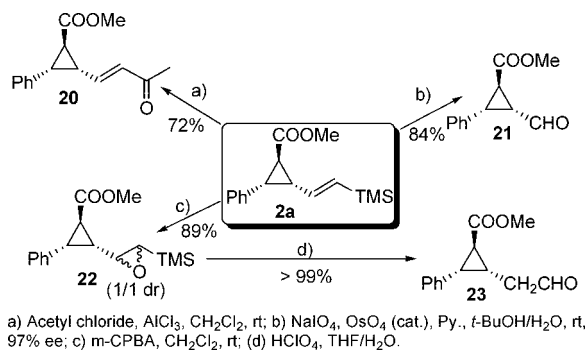
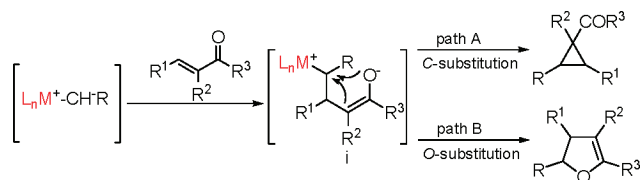
SCHEME 14. Cyclopropanation of Arsonium Allylides with Alkylidene and Arylidene Malonates**SCHEME 15.** Chemical Transformation of Vinylcyclopropanes**SCHEME 16.** Two Pathways for Reactions of α,β -Unsaturated Ketones with Ylide

The vinylcyclopropanes are potentially useful in organic synthesis.¹⁴ As shown in Scheme 15, trimethylsilylvinylcyclopropane **2a** was easily oxidized into aldehyde **21** without the loss of optical purity, which is a key intermediate for the synthesis of the biologically active compounds phenylcarboxycyclopropylglycines (PCCGs). The successful transformations of **2a** into ketone **20**, epoxide **22**, and aldehyde **23** have also been carried out (Scheme 15). Compounds **20–23** are intermediates feasible for various further transformations.

Michael Addition/Substitution To Form Tetrasubstituted Dihydrofuran. As a well-accepted mechanism, the Michael addition of ylide to α,β -unsaturated ketones will produce a betaine intermediate. This intermediate can potentially undergo intramolecular substitution in two pathways: C-substitution (path A in Scheme 16) and O-substitution (path B in Scheme 16), which lead to the formation of cyclopropanes and dihydrofurans, respectively. In most cases, the reactions of ylides with α,β -unsaturated ketones afford cyclopropanes.

TABLE 4. Synthesis of Dihydrofuran Derivatives from Ylide

R	yield (%)	trans/cis	ee (%)
Ph	95	10/1	91
<i>p</i> -ClC ₆ H ₄	88	15/1	93
<i>p</i> -BrC ₆ H ₄	90	14/1	94
<i>p</i> -NO ₂ C ₆ H ₄	95	12/1	92
<i>p</i> -MeC ₆ H ₄	80	10/1	88
<i>o</i> -furyl	92	6.5/1	89
2- <i>E</i> -cinnamyl	89	14/1	94
Et	86	12/1	95

In contrast, the creation of dihydrofurans via ylide Michael addition/substitution is far underdeveloped. A stereoselective synthesis of dihydrofurans via an ylide approach would face the challenge to control the regioselectivity, chemoselectivity, diastereoselectivity (cis/trans), and enantioselectivity.

The reaction of ethyl (dimethylsulfuranylidene)acetate (EDSA) with α,β -unsaturated ketones furnished cyclopropanes.²³ Recently, we found that the same ylide reacted with alkylidene and 3-arylidene-2,4-pentanediones to afford dihydrofuran derivatives with high selectivities rather than cyclopropanes, probably because the steric hindrance of α -substituents of the carbonyl group retarded the 1,3-substitution to form cyclopropanes. By employing camphor-derived sulfur ylide **24** instead of EDSA, we developed a diastereoselective (dr > 6.5/1) and highly enantioselective (>88% ee) cyclization reaction for the preparation of optically active highly substituted dihydrofurans (Table 4). Various α -ylidene- β -diketones proved to be good substrates for this annulation.²⁴

Michael Addition/Substitution To Form Isoxazoline *N*-Oxide. The success of producing dihydrofurans by the reactions of α -ylidene- β -diketones with sulfonium ylides encouraged us to further explore the possibility to synthesize other five-membered heterocyclic compounds. In the presence of K₂CO₃, dimethylsulfonium salt **25** reacted with (*Z*)-benzyl α -nitro- α,β -unsaturated esters, leading to isoxazoline *N*-oxides²⁵ that were frequently used as intermediates in the synthesis of complicated molecules.²⁶ In all cases investigated, the diastereomeric ratios (trans/cis) were higher than 99/1, and no cyclopropane derivatives were observed (Table 5). Camphor-derived sulfonium salt **26** for the enantioselective synthesis of isoxazoline *N*-oxides proved to be inefficient, and only low ee's were obtained. Fortunately, ammonium salts **27** and **28** prepared from cinchonidine and cinchonine gave good results. In the presence of Cs₂CO₃, ammonium salts **27** reacted smoothly with 3-aryl and 3-heteroaryl-2-nitro acry-

TABLE 5. Cyclization of Ylide with Nitroolefins

R/R'	25		27		ee (%)
	yield (%)	trans/cis	yield (%)	trans/cis	
Ph/Bn	91	>99/1	65	>99/1	>99
<i>p</i> -MeOC ₆ H ₄ /Bn	99	>99/1	75	>99/1	99
<i>o</i> -MeOC ₆ H ₄ /Me	88	>99/1	54	>99/1	99
<i>p</i> -MeC ₆ H ₄ /Bn	94	>99/1	77	>99/1	>99
<i>p</i> -FC ₆ H ₄ /Me	92	>99/1	79	>99/1	99
<i>o</i> -furyl/Bn	93	>99/1	67	>99/1	>99
<i>i</i> -C ₃ H ₇ /Me	70	>99/1	30	80/20	99

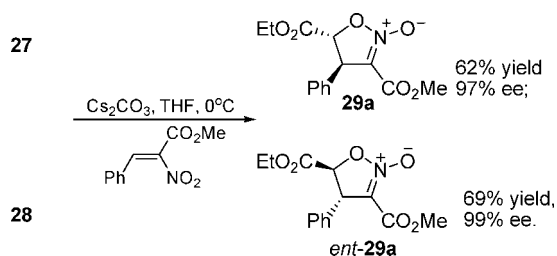
SCHEME 17. Synthesis of Both Enantiomers of Isoxazoline *N*-Oxide 29a

lates, affording (*R,R*)-isoxazoline *N*-oxides as single diastereomers (trans/cis > 99/1) with over 96% ee in good yields. The enantiomeric excesses are nearly independent of the substituents of the aryl and heteroaryl groups (Table 5).

Noticeably, the same cyclization went smoothly using cinchonine-derived salt **28**, affording the desired product in 99% ee but with opposite configuration. Thus, both enantiomers of isoxazoline *N*-oxide were obtained easily just by a simple alternation of the chiral ammonium salts (Scheme 17).

Ent-**29a** can be easily transformed into dehydroclausenamide, a potentially hepatoprotective amide isolated from dry leaves of traditional Chinese medicine *Clausena lansium*. As shown in Scheme 18,²⁷ ent-**29a** was deoxygenated to isoxazoline **30** by trimethylphosphite. The resulting isoxazoline was treated with Raney Ni under H₂ atmosphere, followed by the methylation and treatment with PhLi to give phenylketone **33**, which is able to be conveniently transformed into dehydroclausenamide **34** in two steps according to literature.^{27b} Thus, the enantioselective formal total synthesis of dehydroclausenamide is achieved in seven steps using nitroolefin as a starting material.

SCHEME 18. Formal Synthesis of Dehydroclausenamide 34

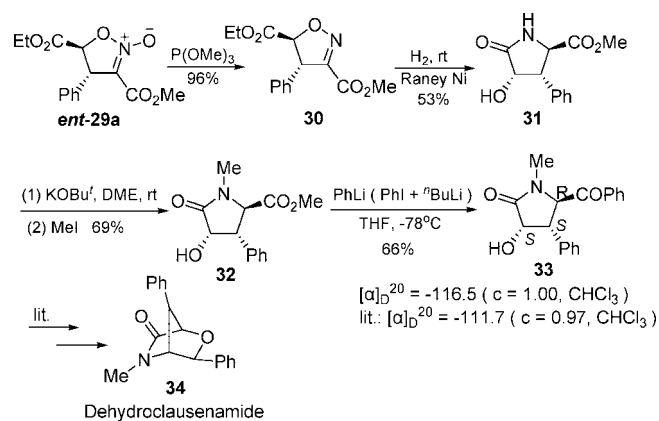
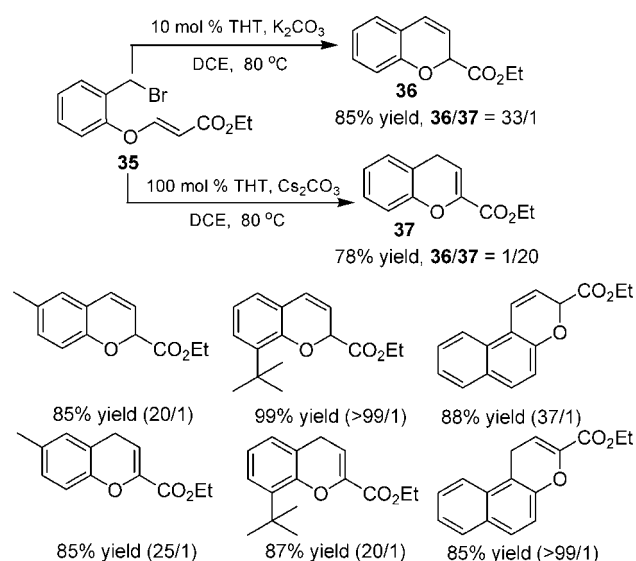
SCHEME 19. Control Synthesis of 2*H*-Chromenes and 4*H*-Chromenes

Ylide-Initiated Michael Addition/Tandem Cyclization

Tandem reactions are powerful synthetic tools for rapid creation of complex molecules, in particular cyclic molecules, with environmental friendliness, operational simplicity, and atom economy.²⁸ Ylides have been demonstrated to be very effective initiators for tandem cyclization reactions.

Michael Addition/Elimination/Substitution To Form Chromene. The wide utility of chromenes²⁹ provides a strong impetus to develop effective methods for the synthesis of such compounds. In the presence of 10 mol % tetrahydrothiophene (THT), upon treatment of K₂CO₃, substrate **35** furnished 2*H*-chromene **36** in 85% yield. With Cs₂CO₃ as the base, interestingly, 4*H*-chromene **37** was selectively obtained in 78% yield (36/37 = 1/20) (Scheme 19).³⁰ A variety of acrylates were suitable substrates for the selective synthesis of 2*H*-chromenes or 4*H*-chromenes by the choice of K₂CO₃ or

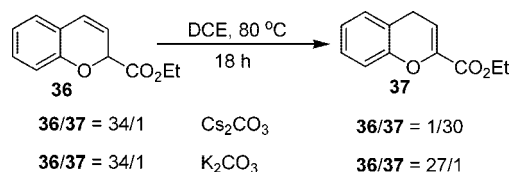
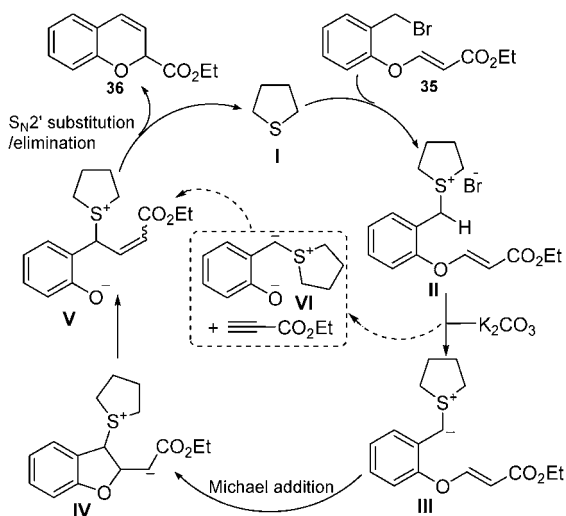
SCHEME 20. Isomerization of 2*H*-Chromene to 4*H*-Chromene

SCHEME 21. Possible Mechanism for the Formation of 2*H*-Chromene

Cs_2CO_3 . Both electronic and steric variations on aryl groups did not result in obvious changes in yields. The ratio of 2*H*-chromene/4*H*-chromene implied that this reaction is substrate-dependent. It is worth noting that the reaction can afford 2*H*-chromene in high yield even with 1 mol % catalyst loading.

The base effects in this reaction were attributed to the different basicity of K_2CO_3 and Cs_2CO_3 . As shown in Scheme 20, when a mixture of 2*H*-chromene/4*H*-chromene was treated with a base in DCE at 80 °C, 2*H*-chromene was almost completely isomerized into 4*H*-chromene after 18 h in the case of Cs_2CO_3 being applied. The same transformation proceeded very slowly in the presence of K_2CO_3 (Scheme 20). This hypothesis was further supported by ^1H NMR monitoring of the annulation reaction.³⁰

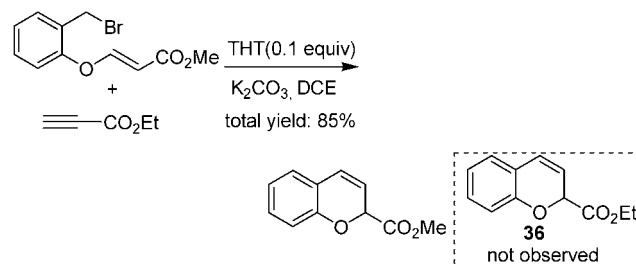
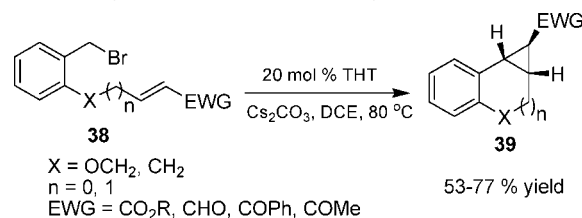
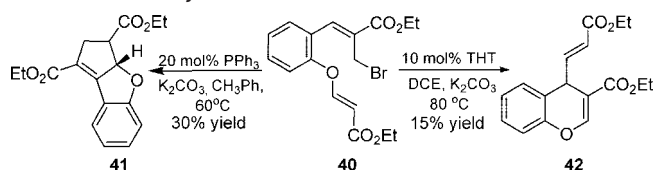
The mechanism for the formation of 2*H*-chromene can be described as follows (Scheme 21). Tetrahydrothiophene reacts with bromide **35** to form sulfonium salt **II**, which is subsequently deprotonated to generate the corresponding sulfonium ylide **III** in situ. An intramolecular Michael addition of the ylide to acrylate followed by a β -elimination produces **V**. $\text{S}_{\text{N}}2'$ substitution of intermediate **V** affords 2*H*-chromene. The second possible pathway for the production of intermediate **V** from sulfonium salt **II** is via decomposition of salt **II** into ylide **VI** and ynoate in the presence of base, followed by a Michael

SCHEME 22. Cross Experiment

SCHEME 23. Synthesis of Benzo[*n*.1.0]bicycloalkanes

SCHEME 24. Catalytic Ylide Annulation

addition of ylide **VI** to the ynoate. Because 2*H*-chromene **36** was not observed in a cross-experiment as shown in Scheme 22, the first pathway, which involves an intramolecular Michael addition/ β -elimination, is more reasonable.³¹

On the basis of the mechanism, the C–O cleavage involved in the β -elimination is one of the key steps to form 2*H*-chromene. When substrates **38** were used, the β -elimination step was inhibited and cyclopropanes **39** were obtained in good yields under similar reaction conditions using Cs_2CO_3 (Scheme 23). These results further confirmed the aforementioned mechanism and provided an easy access to benzo[*n*.1.0]bicycloalkanes.³¹

Double Michael Addition/Elimination To Form [*n*.3.0]-Bicyclic Compounds. The chemical behaviors of ylides proved to be dependent on both the heteroatom and the ligand, resulting in different reactions for the same substrates. As shown in Scheme 24, the reactions of bromide **40**, initiated by triphenylphosphine (PPh_3), furnished [3.3.0] compound **41**, and the same substrate gave 4*H*-chromene **42** when THT was used instead of PPh_3 under the similar conditions.³²

By replacement of phenoxyacrylate **40** with phenoxycrotonate **43**, benzobicyclo[4.3.0] compounds **44** were prepared in high yields in the presence of Na_2CO_3 and 20 mol % PPh_3 (Table 6). When α -methyl α,β -unsaturated esters **43** were employed,

TABLE 6. Intramolecular Phosphine-Catalyzed Annulation Reaction

R/R'	yield (%)	dr (44)	44/45
H/H	95	>99/1	91/9
Cl/H	99	>99/1	94/6
OMe/H	96	>99/1	91/9
H/Me	82	93/7	100/0
Cl/Me	78	95/5	100/0

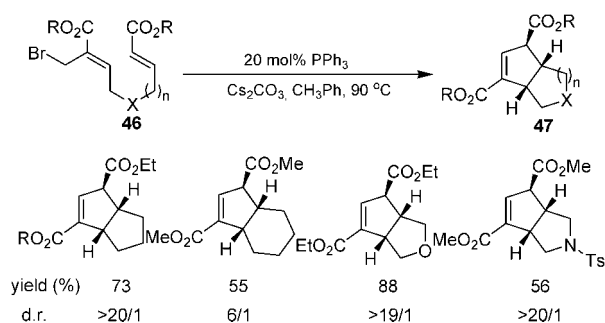
SCHEME 25. Intramolecular Phosphine-Catalyzed Ylide Annulation Reaction

noticeably, the reaction also proceeded very well to give benzo-bicyclo[4.3.0] compounds with a quaternary carbon.³³

The substrate scope is quite general for this annulation reaction. As shown in Scheme 25, aliphatic substrates worked well to afford both bicyclo[3.3.0] and bicyclo[4.3.0] compounds with high diastereoselectivities in moderate to good yields. In contrast to that for bicyclo[3.3.0] compounds, the diastereoselectivity for bicyclo[4.3.0] was reduced slightly.³²

This annulation was also performed under neutral conditions when the corresponding *tert*-butyl carbonate was used instead of the bromides. This modification allowed the reaction temperature to be decreased from 90 °C to room temperature with 20 mol % of tributyl phosphine (Scheme 26).³²

Although the present reaction usually gave a mixture of two isomers, both isomers were readily hydrogenated and transformed into a single compound. For example, a mixture of **44a** and **45a** was subjected to hydrogenation, affording the same product **50** (Scheme 27).³⁴

The tentative mechanism of annulation reaction is shown in Scheme 28. Triphenylphosphine reacts with the bromide to generate phosphonium salt **I**, which is deprotonated by the base to produce the corresponding phosphonium ylide **II** in situ. Double Michael additions, followed by β -elimination of

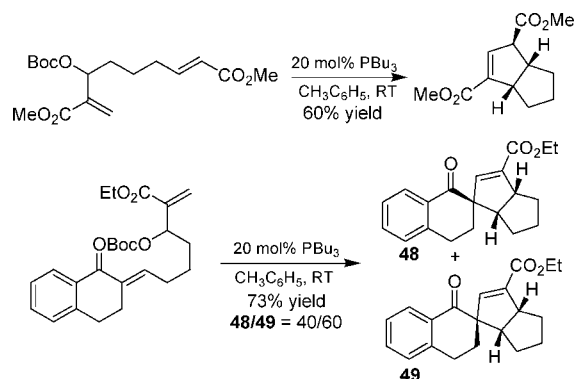
SCHEME 26. Annulation of Carbamate Derivatives^a

^a Boc = *tert*-butoxycarbonyl.

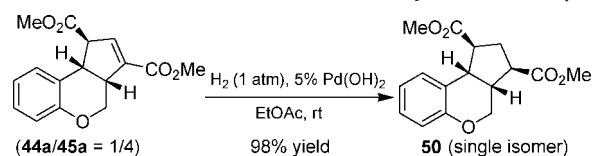
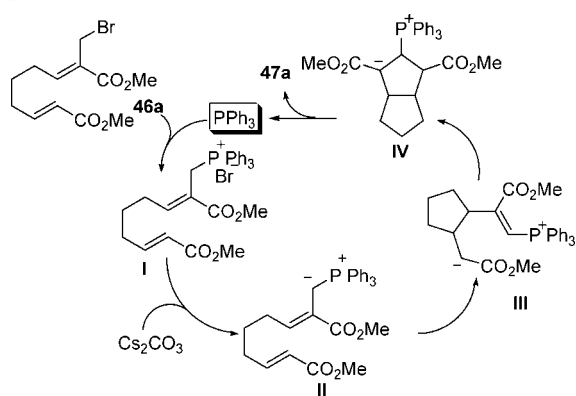
SCHEME 27. Chemical Transformation of Bicyclo[*n*.3.0] Compounds**SCHEME 28.** A Plausible Mechanism for Triphenylphosphine-Catalyzed Annulation Reaction

triphenylphosphine, afford the product to complete the catalytic cycle.³²

Michael Addition/Epoxidation To Form Cyclohexadiene Epoxides. Generally, the reactions of allylic sulfur ylide with α,β -unsaturated ketones were reported to afford vinylcyclopropanes.^{13,14,16} However, we found that sulfur ylide derived from crotonate reacted with α,β -unsaturated ketones in a different manner. In this case, cyclopropanes were not observed, and the reaction afforded cyclohexadiene epoxides, which are very important subunits in a number of biologically active compounds and are versatile intermediates in organic synthesis.³⁵ Both β -aryl- and β -alkyl-substituted α,β -unsaturated ketones furnished the desired products in good to high yields with excellent diastereoselec-

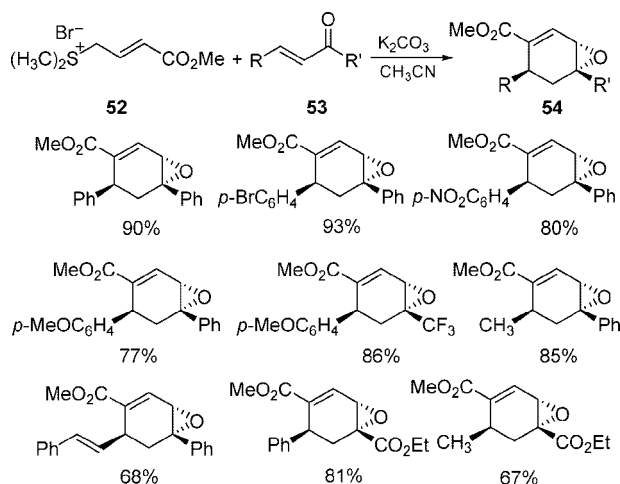
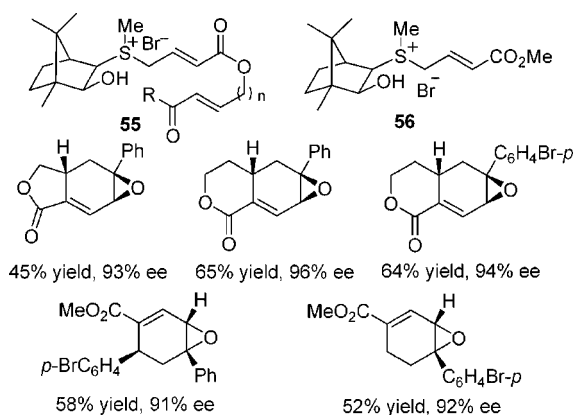
SCHEME 29. Tandem Michael Addition/Ylide Epoxidation Reaction

SCHEME 30. Asymmetric Ylide Michael Addition/Epoxidation

tivities (>99/1). Substituents on the aryl ring proved to be well-tolerated and influenced slightly the yields (Scheme 29).³⁶

The intramolecular version of this reaction proceeds smoothly, affording the desired tricyclic cyclohexadiene epoxides with excellent diastereoselectivities (>99/1) in good to high yields. Although they involve a remote control of enantioselectivity, both intermolecular and intramolecular reactions worked very well by employing *d*-camphor-derived sulfonium salts, furnishing the desired epoxides with >91% ee's in moderate to good yields (Scheme 30).

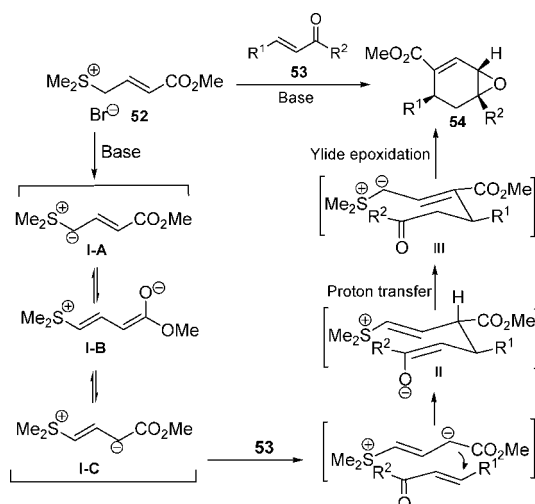
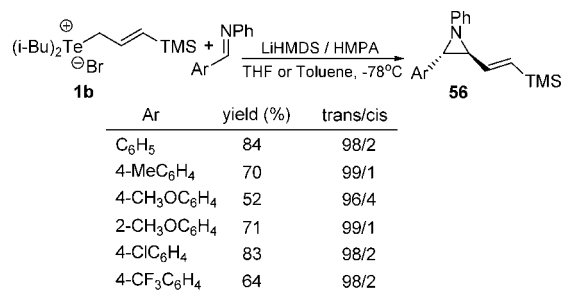
The aforementioned reaction can be explained by a proposed mechanism shown in Scheme 31. Ylide **I-C**, generated *in situ* from the corresponding sulfonium salt **52** under basic conditions, undergoes an intermolecular Michael addition with α,β -unsaturated ketones to form intermediate **II**. Proton transfer of intermediate **III**, followed by an intramolecular ylide epoxidation affords the desired cyclohexadiene epoxide derivative **54**.

SCHEME 31. A Plausible Mechanism for the Formation of Cyclohexadiene Epoxides

SCHEME 32. Stereoselective Synthesis of Aziridines

Miscellaneous Cyclization

Vinylaziridines are important subunits in a number of biologically active compounds and useful building blocks in the synthesis of nitrogen-containing compounds.³⁷ Of the synthetic methods developed for vinylaziridines, the reaction between ylide and imines provided one of the convenient ways. However, the stereoselectivity, in particular the *cis/trans* selectivity, is generally poor. Gratifyingly, we found that telluronium ylide **55**, derived from salt **1b** in the presence of a base, reacted with aromatic *N*-phenyl aldimines to give *trans*-vinylaziridines with high diastereoselectivities in moderate to high yields (Scheme 32). It is reported that aliphatic aldimine is easily isomerized to enamine and a few alkylimines but *tert*-butyl *N*-tosyl imine is subjected to ylide aziridination. By a one-pot strategy, telluronium allylide **55** reacts with *N*-Boc-aliphatic imines, generated *in situ* from compounds **57** to afford *cis*-*N*-Boc-aziridines with high selectivities in good yields (Scheme 33).³⁸

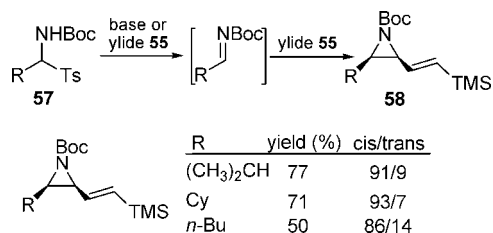
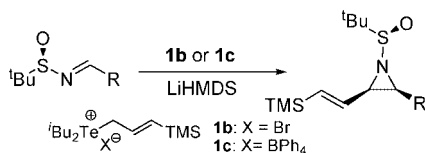
When chiral *N*-*tert*-butylsulfonilymines were used, the optically active *cis*-2-substituted vinylaziridines were obtained. Various aryl and heteroaryl aldimines, as well as alkyl and α,β -unsaturated aldimines all afforded the desired products with high diastereoselectivities (>98% de) in good to excellent yields

SCHEME 33. Stereoselective Synthesis of Aziridines by a One-Pot Strategy**TABLE 7.** Stereoselective Aziridination of Enantiopure *N*-*tert*-Butylsulfonfylimines

R	yield (%)	cis/trans	de
Ph	98	20/1	>98
<i>p</i> -ClC ₆ H ₄	96	20/1	>98
<i>p</i> -CF ₃ C ₆ H ₄	98	20/1	>98
<i>p</i> -MeC ₆ H ₄	98	20/1	97
1-naphthyl	98	22/1	>98
2-furyl	93	19/1	94
Cy	83	9/1	>98
<i>t</i> -Bu	53	>30/1	>98
	98	25/1	87
	91	12/1	86

Both the sulfonium and telluronium allylides are also useful for the preparation of vinyl epoxides. In the presence of 5 mol% (or 1 mol %) of THT⁴⁰ (or telluronium salt⁴¹), aromatic and aliphatic aldehydes react with allylic bromide very well to give the desired epoxides.

(Table 7). Ketimines, usually less reactive than aldimines in ylide reactions, were also suitable substrates for this aziridination.³⁹

Conclusion

Ylide-initiated Michael addition/cyclizations are complex from the perspective of chemoselectivity, regioselectivity, and stereoselectivity. By alteration of the heteroatoms or the ligands of the ylides, the selectivities have proven to be controllable, providing a powerful tool to construct diverse cyclic compounds beyond cyclopropanes. Telluronium and sulfonium allylides can react with Michael acceptors to afford multisubstituted vinylcyclopropane with high selectivities. The reactions of carboalkoxymethylides with α -ylidene- β -diketones and nitroolefins furnish dihydrofurans and isoxazoline *N*-oxides, respectively. By rational design of ylides and the substrates, ylide Michael addition/tandem cyclizations have been applied to the synthesis of chromenes, bicyclic compounds,

cyclohexadiene epoxides. These results show that ylides are excellent reagents for the preparation of cyclic compounds beyond three-membered rings with controllable selectivities.

We are deeply indebted to highly talented group members whose names are listed in the relevant references. We are grateful for the financial support from the National Natural Sciences Foundation of China, the Major State Basic Research Development Program (Grant No. 2006CB806105), The Chinese Academy of Sciences, and The Science and Technology Commission of Shanghai Municipality.

BIOGRAPHICAL INFORMATION

Xiu-Li Sun was born in 1971 in Inner Mongolia, China. She received her Ph.D. degree in 2000 at Nankai University under the supervision of Professor Xiu-Zhong Zhou. In 2000, she joined the group of Prof. Yong Tang at Shanghai Institute of Organic Chemistry as a research associate. She is currently an associate Professor at the same institute. Her research interests focus on the development of new catalysts for olefin polymerization and asymmetric synthesis.

Yong Tang was born in September 1964 in Sichuan, China. He received his Ph.D. degree in 1996 at Shanghai Institute of Organic Chemistry, Chinese Academy of Sciences, under the supervision of Prof. Yao-Zeng Huang and Prof. Li-Xin Dai. Having spent three years as a postdoctoral researcher in the USA, he joined Shanghai Institute of Organic Chemistry, CAS, in 1999 as an associate Professor. He was promoted to a full Professor in 2000. His current research interests are the development of new synthetic methodologies and the design and synthesis of olefin polymerization catalysts.

FOOTNOTES

* To whom correspondence should be addressed. E-mail: tangy@mail.sioc.ac.cn.

REFERENCES

- For a review on catalytic ylide cyclization via a metal carbene route, see: (a) Aggarwal, V. K.; Winn, C. L. Catalytic Asymmetric Sulfur Ylide-Mediated Epoxidation of Carbonyl Compounds: Scope, Selectivity, and Applications in Synthesis. *Acc. Chem. Res.* **2004**, *37*, 611–620. Selected examples: (b) Aggarwal, V. K.; Smith, H. W.; Hynd, G.; Jones, R. V. H.; Fieldhouse, R.; Spey, S. E. Catalytic Cyclopropanation of Electron Deficient Alkenes Mediated by Chiral and Achiral Sulfides: Scope and Limitations in Reactions Involving Phenyl diazomethane and Ethyl Diazoacetate. *J. Chem. Soc., Perkin Trans. 1* **2000**, 3267–3276. (c) Aggarwal, V. K.; Alonso, E.; Fang, G.; Ferrara, M.; Hynd, G.; Porcelloni, M. Application of Chiral Sulfides to Catalytic Asymmetric Aziridination and Cyclopropanation with *in Situ* Generation of the Diazo Compound. *Angew. Chem., Int. Ed.* **2001**, *40*, 1433–1436. (d) Aggarwal, V. K.; Grange, E. Asymmetric Sulfonium Ylide Mediated Cyclopropanation: Stereocontrolled Synthesis of (+)-LY354740. *Chem.—Eur. J.* **2006**, *12*, 568–575. (e) Zhu, S.-F.; Liao, Y.; Zhu, S.-Z. The First Example of Catalytic Aziridination Mediated by Arsonium Ylides: Preparation of *trans*-Pentafluorophenyl-Containing Aziridines. *Synlett* **2005**, 1429–1432.
- For selected recent examples on organocatalytic ylide cyclization, see: (a) Bremeyer, N.; Smith, S. C.; Ley, S. V.; Gaunt, M. J. An Intramolecular Organocatalytic Cyclopropanation Reaction. *Angew. Chem., Int. Ed.* **2004**, *43*, 2681–2684. (b) Papageorgiou, C. D.; de Dios, M. A. C.; Ley, S. V.; Gaunt, M. J. Enantioselective Organocatalytic Cyclopropanation via Ammonium Ylides. *Angew. Chem., Int. Ed.* **2004**, *43*, 4641–4644. (c) Johansson, C. C. C.; Bremeyer, N.; Ley, S. V.; Owen, D. R.; Smith, S. C.; Gaunt, M. J. Enantioselective Catalytic Intramolecular

- Cyclopropanation Using Modified Cinchona Alkaloid Organocatalysts. *Angew. Chem., Int. Ed.* **2006**, *45*, 6024–6028. (d) Kunz, R. K.; MacMillan, D. W. C. Enantioselective Organocatalytic Cyclopropanations. The Identification of a New Class of Iminium Catalyst Based upon Directed Electrostatic Activation. *J. Am. Chem. Soc.* **2005**, *127*, 3240–3241.
- 3 For reviews, see: (a) Dai, L.-X.; Hou, X.-L.; Zhou, Y.-G. Stereoselective Synthesis of Three-membered ring Compounds via Ylide Routes. *Pure Appl. Chem.* **1999**, *71*, 369–376. (b) Li, A.-H.; Dai, L.-X.; Aggarwal, V. K. Asymmetric Ylide Reactions: Epoxidation, Cyclopropanation, Aziridination, Olefination, and Rearrangement. *Chem. Rev.* **1997**, *97*, 2341–2372. (c) McGarrigle, E. M.; Myers, E. L.; Illa, O.; Shaw, M. A.; Riches, S. L.; Aggarwal, V. K. Chalcogenides as Organocatalysts. *Chem. Rev.* **2007**, *107*, 5841–5883. (d) Gaunt, M. J.; Johansson, C. C. C. Recent Developments in the Use of Catalytic Asymmetric Ammonium Enolates in Chemical Synthesis. *Chem. Rev.* **2007**, *107*, 5596–5605. (e) Lebel, H.; Marcoux, J. F.; Molinaro, C.; Charette, A. B. Stereoselective Cyclopropanation Reactions. *Chem. Rev.* **2003**, *103*, 977–1050.
 - 4 Block, E. Synthetic Applications of Sulphonium Salts and Sulphonium Ylides. In *The Chemistry of the Sulphonium Group*; Stirling, C. J. M., Patai, S., Eds.; Wiley: New York, 1981; pp 673–702.
 - 5 Usuka, A.; Mori, Y.; Shimizu, H.; Suzuki, H. A New Synthesis of α,β -Unsaturated Carboxylic Esters Using Dialkyltellurium Carboxymethylide. *Tetrahedron Lett.* **1983**, *24*, 2599–2602.
 - 6 Huang, Y.-Z.; Tang, Y.; Zhou, Z.-L.; Huang, J.-L. Michael Addition of Silylated Tellurium Allylide to α,β -Unsaturated Esters: Facile and Stereoselective Synthesis of Trimethylsilylvinylcyclopropane Derivatives. *J. Chem. Soc., Chem. Commun.* **1993**, 7–9.
 - 7 Tang, Y.; Huang, Y. Z.; Dai, L.-X.; Sun, J.; Xia, W. Cyclopropanation Reactions of Allylic Ylides with α,β -Unsaturated Esters and Amides: Tuning of Stereoselectivity and the Dramatic Effect of Lithium Salts. *J. Org. Chem.* **1996**, *61*, 5762–5769.
 - 8 (a) Ye, S.; Tang, Y.; Dai, L. X. Switching of Stereoselectivity: Dramatic Effects of HMPA on the Stereoselectivity of Cyclopropanation Reaction of Silylated Tellurium Allylide with α,β -Unsaturated Esters and Amides. *J. Org. Chem.* **2000**, *65*, 6257–6260. (b) Tang, Y.; Ye, S.; Sun, X.-L. Tellurium and Sulfonium Ylides for Organic Transformation. *Synlett* **2005**, 2720–2730.
 - 9 Tang, Y.; Huang, Y.-Z.; Dai, L.-X.; Sun, J.; Xia, W. An Efficient Stereocontrolled Strategy in the Cyclopropanation Reactions of α,β -Unsaturated Ketones with Semistabilized Ylides: Highly Selective Synthesis of Two Geometrical Isomers of Vinylcyclopropane Derivatives. *J. Org. Chem.* **1997**, *62*, 954–959.
 - 10 Doyle, M. P.; Forbes, D. C. Recent Advances in Asymmetric Catalytic Metal Carbene Transformations. *Chem. Rev.* **1998**, *98*, 911–936.
 - 11 (a) Cheng, D.; Knox, K. R.; Cohen, T. Tandem Lithium-ene Cyclization and Thiophenoxide Expulsion to Produce Fused Vinylcyclopropanes: First Observation of Allylic Lithium Oxyanion-induced Reactivity and Stereoselectivity in Intramolecular Carbolithiation. *J. Am. Chem. Soc.* **2000**, *122*, 412–413. (b) Ma, S.; Zhao, S. Reverse of Regioselectivity in Intramolecular Nucleophilic Substitution of μ -Allyl Palladium Species. Highly Selective Formation of Vinylcyclopropanes via the Pd(O)-catalyzed Coupling-cyclization Reaction of Organic Iodides with 2-(2',3'-Dienyl)malonates. *Org. Lett.* **2000**, *2*, 2495–2497.
 - 12 Liao, W.-W.; Li, K.; Tang, Y. Controllable Diastereoselective Cyclopropanation. Enantioselective Synthesis of Vinylcyclopropanes via Chiral Tellurium Ylides. *J. Am. Chem. Soc.* **2003**, *125*, 13030–13031.
 - 13 Liao, W.-W. Stereoselective Ylide Cyclopropanation and Aziridination, Ph D thesis, Shanghai Institute of Organic Chemistry, Chinese Academy of Sciences, 2004, pp 5–66.
 - 14 Ye, S.; Huang, Z.-Z.; Xia, C.-A.; Tang, Y.; Dai, L.-X. A Novel Chiral Sulfonium Ylide: Highly Enantioselective Synthesis of Vinylcyclopropanes. *J. Am. Chem. Soc.* **2002**, *124*, 2432–2433.
 - 15 For the preparation of sulfide **12**, see: Li, A.-H.; Dai, L.-X.; Hou, X.-L.; Huang, Y.-Z.; Li, F.-W. Preparation of Enantiomerically Enriched (2*R*,3*R*)- or (2*S*,3*S*)-*trans*-2,3-Diaryloxiranes via Camphor-Derived Sulfonium Ylides. *J. Org. Chem.* **1996**, *61*, 489–493.
 - 16 Deng, X.-M.; Cai, P.; Ye, S.; Sun, X.-L.; Liao, W.-W.; Li, K.; Tang, Y.; Wu, Y.-D.; Dai, L.-X. Enantioselective Synthesis of Vinylcyclopropanes and Vinyl epoxides Mediated by Camphor-Derived Sulfur Ylides: Rationale of Enantioselectivity, Scope, and Limitation. *J. Am. Chem. Soc.* **2006**, *128*, 9730–9740.
 - 17 Zhou, Z.-L.; Sun, Y.-S.; Shi, L.-L.; Huang, Y.-Z. A Facile Synthesis of α,β -Unsaturated Epoxides via Diisobutylallyltellurium Bromide. *J. Chem. Soc., Chem. Commun.* **1990**, 1439–1440.
 - 18 Zheng, J.-C.; Liao, W.-W.; Tang, Y.; Sun, X.-L.; Dai, L.-X. The Michael Addition-Elimination of Ylides to α,β -Unsaturated Imines. Highly Stereoselective Synthesis of Vinylcyclopropanecarbaldehydes and Vinylcyclopropylaziridines. *J. Am. Chem. Soc.* **2005**, *127*, 12222–12223.
 - 19 Tang, Y.; Chi, Z.-F.; Huang, Y.-Z.; Dai, L.-X.; Yu, Y.-H. Highly Stereoselective Synthesis of Vinyl and Ethynylcyclopropane 1,1-Dicarboxylic Esters via Semistabilized Tellurium Ylides. *Tetrahedron* **1996**, 8747–8757.
 - 20 Reissig, H.-U.; Zimmer, R. Donor-Acceptor-Substituted Cyclopropane Derivatives and Their Application in Organic Synthesis. *Chem. Rev.* **2003**, *103*, 1151–1196.
 - 21 Jiang, H.; Deng, X.-M.; Sun, X.-L.; Tang, Y.; Dai, L.-X. Highly Stereoselective Synthesis of Trisubstituted Vinylcyclopropane Derivatives via Arsonium Ylides. *J. Org. Chem.* **2005**, *70*, 10202–10205.
 - 22 Jiang, H.; Sun, X.-L.; Zhu, C.-Y.; Dai, L.-X.; Tang, Y. AsPh₃-catalyzed Ylide Cyclopropanation for the Synthesis of Trisubstituted Vinylcyclopropane Derivatives. *Tetrahedron* **2008**, *64*, 5032–5035.
 - 23 Payne, G. B. Cyclopropanes from Reactions of Ethyl Dimethylsulfuranylideneacetate with α,β -Unsaturated Compounds. *J. Org. Chem.* **1967**, *32*, 3351–3355.
 - 24 Zheng, J.-C.; Zhu, C.-Y.; Sun, X.-L.; Tang, Y.; and Dai, L.-X. Highly Diastereoselective and Enantioselective Formal [4 + 1] Ylide Annulation for the Synthesis of Optically Active Dihydrofurans. *J. Org. Chem.*, in press.
 - 25 Zhu, C.-Y.; Deng, X.-M.; Sun, X.-L.; Zheng, J.-C.; Tang, Y. Highly Enantioselective Synthesis of Isoxazoline N-oxides. *Chem. Commun.* **2008**, 738–740.
 - 26 Simoni, D.; Grisolia, G.; Giannini, G.; Roberti, M.; Rondanin, R.; Piccagli, L.; Baruchello, R.; Rossi, M.; Romagnoli, R.; Invidiata, F. P.; Grimaudo, S.; Jung, M. K.; Hamel, E.; Gebbia, N.; Crosta, L.; Abbadesse, V.; Di Cristina, A.; Dusonchet, L.; Meli, M.; Tolomeo, M. Heterocyclic and Phenyl Double-bond-locked Combretastatin Analogues Possessing Potent Apoptosis-Inducing Activity in HL60 and in MDR Cell Lines. *J. Med. Chem.* **2005**, *48*, 723–736, and references cited therein.
 - 27 (a) Zhu, C.-Y.; Sun, X.-L.; Deng, X.-M.; Zheng, J.-C.; Tang, Y. Synthesis of Isoxazoline N-oxides and Its Application in the Formal Synthesis of Dehydroclausenamide. *Tetrahedron* **2008**, *64*, 5583–5589. (b) Yan, Z.; Wang, J.; Tian, W. A Concise Total Synthesis of (–)-Dehydroclausenamide Utilizing the Novel Formation of *cis*-Epoxide as the Key Step. *Tetrahedron Lett.* **2003**, *44*, 9383–9384.
 - 28 (a) Chapman, C. J.; Frost, C. G. Tandem and Domino Catalytic Strategies for Enantioselective Synthesis. *Synthesis* **2007**, 1–21. (b) Nicolaou, K. C.; Edmonds, D. J.; Bulger, P. G. Cascade Reactions in Total Synthesis. *Angew. Chem., Int. Ed.* **2006**, *45*, 7134–7186. (c) Guo, H.; Ma, J. Catalytic Asymmetric Tandem Transformations Triggered by Conjugate Additions. *Angew. Chem., Int. Ed.* **2006**, *45*, 354–366.
 - 29 For recent review, see: Shi, Y.-L.; Shi, M. The Synthesis of Chromenes, Chromanes, Coumarins and Related Heterocycles via Tandem Reactions of Salicylic Aldehydes or Salicylic Imines with α,β -Unsaturated Compounds. *Org. Biomol. Chem.* **2007**, *5*, 1499–1504, and references cited therein.
 - 30 Ye, L.-W.; Sun, X.-L.; Zhu, C.-Y.; Tang, Y. An Unexpected Tandem Ylide Annulation Reaction for Controllable Synthesis of 2*H*-Chromenes and 4*H*-Chromenes. *Org. Lett.* **2006**, *8*, 3853–3856.
 - 31 Ye, L.-W.; Sun, X.-L.; Li, C.-Y.; Tang, Y. Tetrahydrothiophene-Catalyzed Synthesis of Benzo[*n*.1.0] Bicycloalkanes. *J. Org. Chem.* **2007**, *72*, 1335–1340.
 - 32 Ye, L.-W.; Sun, X.-L.; Wang, Q.-G.; Tang, Y. Phosphine-Catalyzed Intramolecular Formal [3 + 2] Cycloaddition for Highly Diastereoselective Synthesis of Bicyclo[*n*.3.0] Compounds. *Angew. Chem., Int. Ed.* **2007**, *46*, 5951–5954.
 - 33 Ye, L.-W.; Han, X.; Sun, X.-L.; Tang, Y. PPh₃-Catalyzed Ylide Cyclization for the Controllable Synthesis of Benzobicyclo[4.3.0] Compounds: Base Effects and Scope. *Tetrahedron* **2008**, *64* (7), 1487–1493.
 - 34 Ye, L.-W.; Tang, Y. Unpublished results.
 - 35 Marco-Contelles, J.; Molina, M. T.; Anjum, S. Naturally Occurring Cyclohexane Epoxides: Sources, Biological Activities, and Synthesis. *Chem. Rev.* **2004**, *104*, 2857.
 - 36 Wang, Q.-G.; Deng, X.-M.; Zhu, B.-H.; Ye, L.-W.; Sun, X.-L.; Li, C.-Y.; Zhu, C.-Y.; Shen, Q.; Tang, Y. Tandem Michael Addition/Ylide Epoxidation for the Synthesis of Highly Functionalized Cyclohexadiene Epoxide Derivatives. *J. Am. Chem. Soc.* **2008**, *130*, 5408–5409.
 - 37 (a) Tanner, D. Chiral Aziridines - Their Synthesis and Use in Stereoselective Transformations. *Angew. Chem., Int. Ed.* **1994**, *33*, 599–619. (b) Osborn, H. M. I.; Sweeney, J. B. The Asymmetric Synthesis of Aziridines. *Tetrahedron: Asymmetry* **1997**, *8*, 1693–1715.
 - 38 Liao, W.-W.; Deng, X.-M.; Tang, Y. A Facile Reaction of Imines with Tellurium Allylide. Highly Stereoselective Synthesis of Vinylaziridines. *Chem. Commun.* **2004**, 13, 1516–1517.
 - 39 Zheng, J.-C.; Liao, W.-W.; Sun, X.-X.; Sun, X.-L.; Tang, Y.; Dai, L.-X.; Deng, J.-G. Tellurium Salts Mediated Aziridination of Chiral *N*-tert-Butylsulfonimines: Highly Stereoselective Synthesis of Optically Active Vinylaziridines. *Org. Lett.* **2005**, *7*, 5789–5792.
 - 40 Li, K.; Huang, Z.-Z.; Tang, Y. An Efficient Catalytic Ylide Route to Vinyl Epoxides. *Tetrahedron Lett.* **2003**, *44*, 4137–4140.
 - 41 Li, K.; Deng, X.-M.; Tang, Y. A Facile Tetrahydrothiophene-catalyzed Ylide Route to Vinyl oxiranes. *Chem. Commun.* **2003**, 2074–2075.